

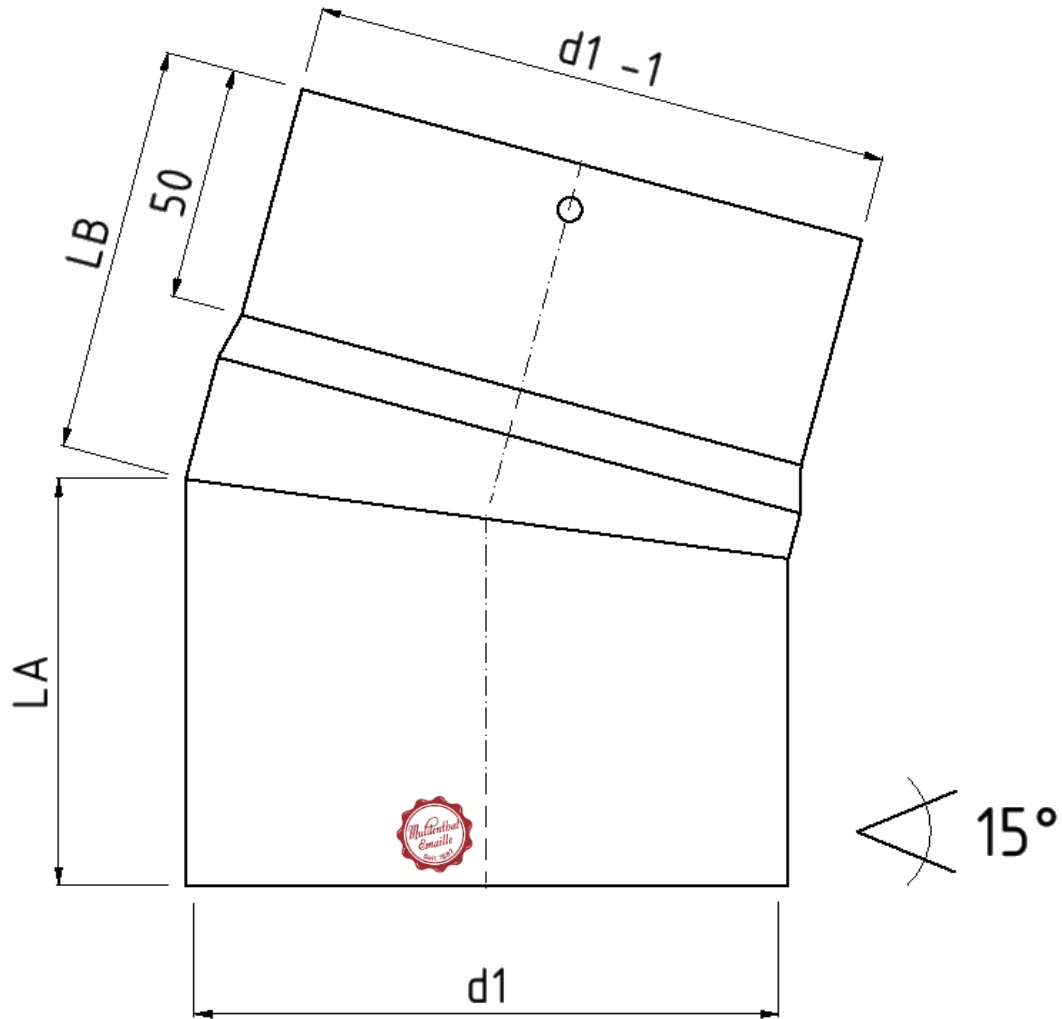

DIMENSIONEN



d1 in mm	LA = LB in mm
Ø 120	86
Ø 130	88
Ø 150	90
Ø 160	92
Ø 180	94
Ø 200	97
Ø 250	103
Ø 300	110