

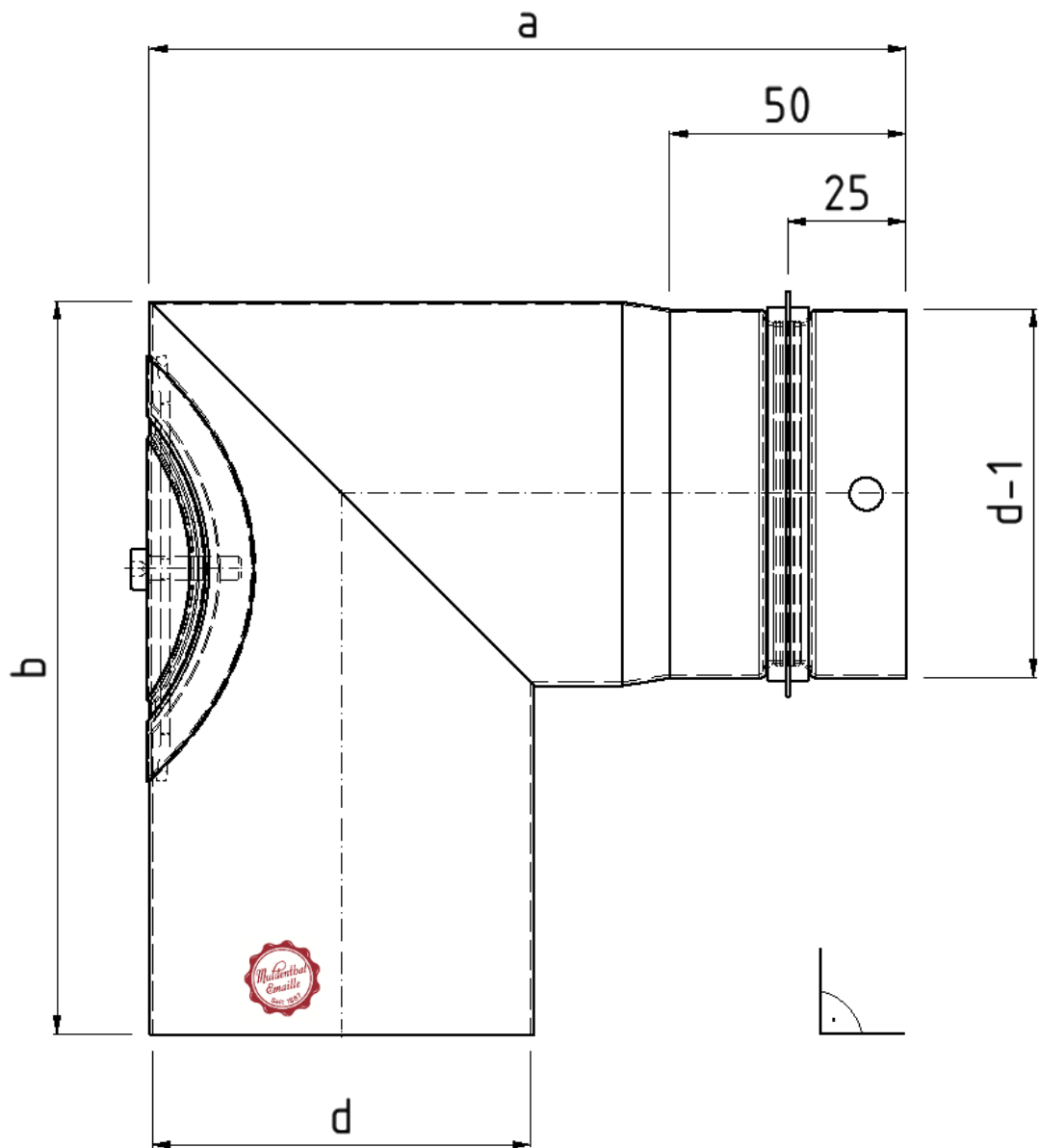

DIMENSIONEN



d in mm	a in mm	b in mm
Ø 80	160	155
Ø 100	175	175
Ø 125	230	230